

SINGLE CARPORT

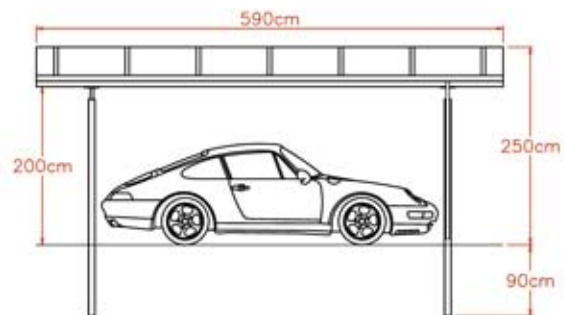

R01

DOUBLE CARPORT

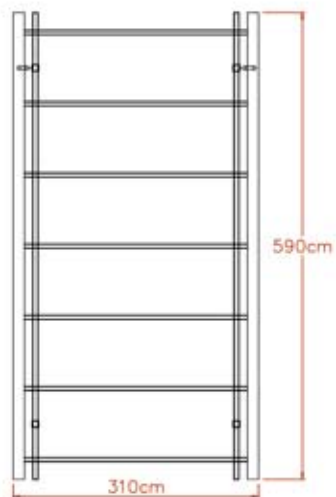
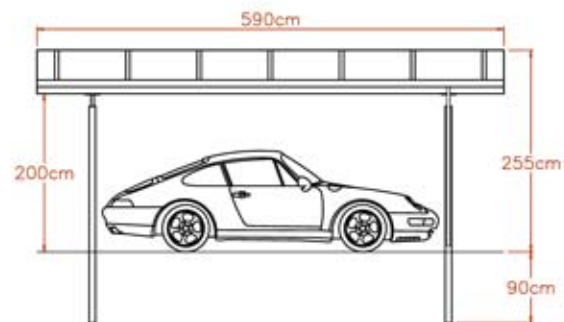
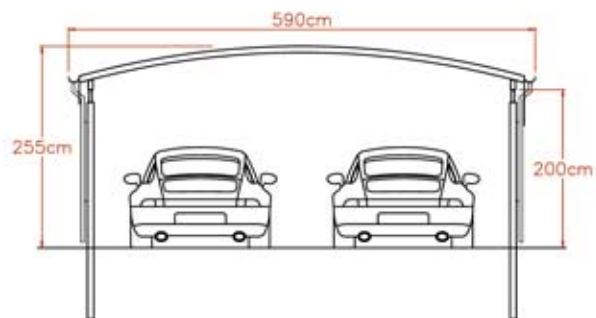
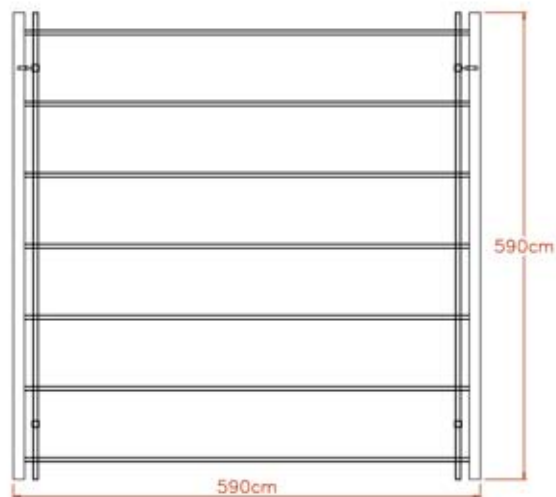

R02

SINGLE ANBAU-CARPORT

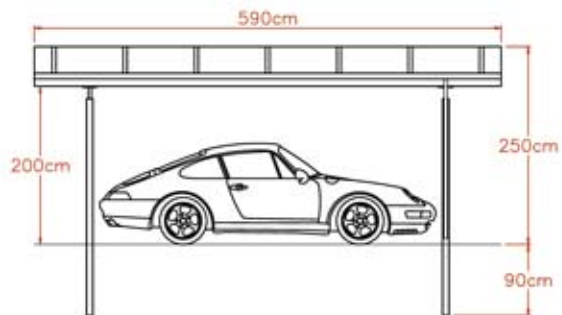
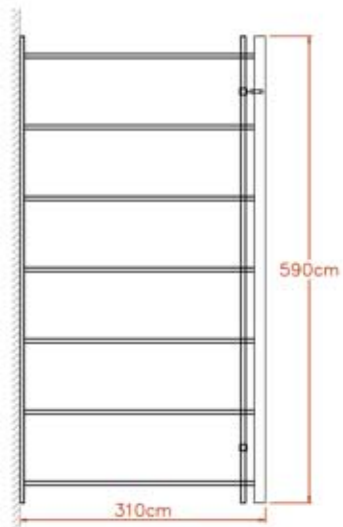

R03

DOUBLE ANBAU-CARPORT

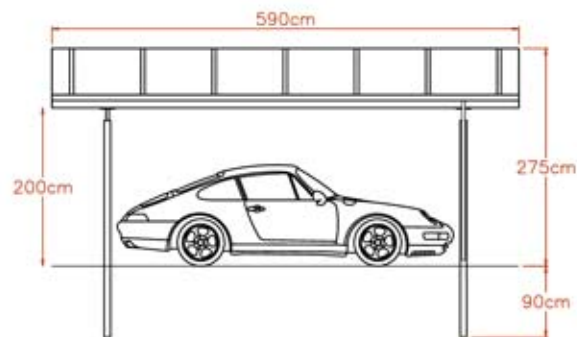
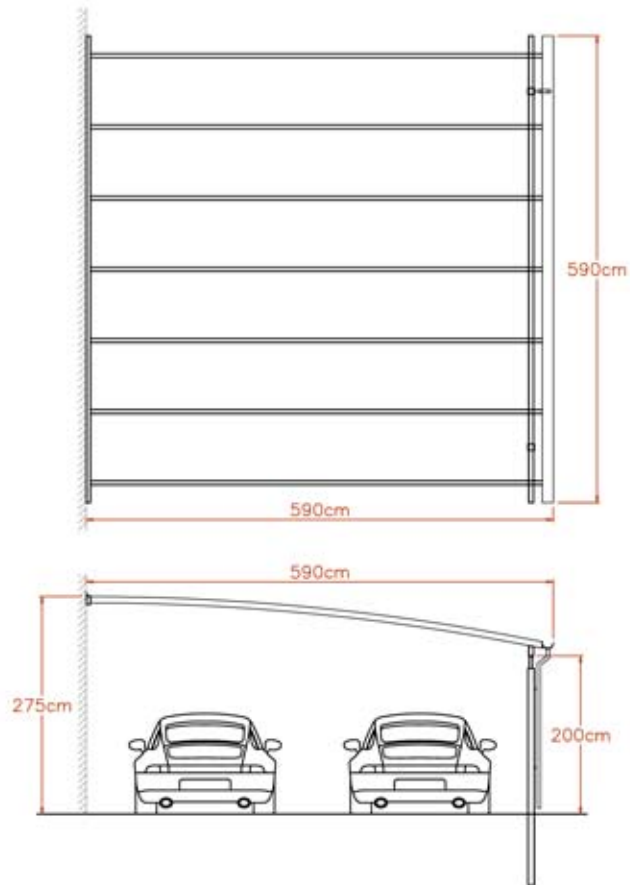

R04

SINGLE ANBAU-CARPORT

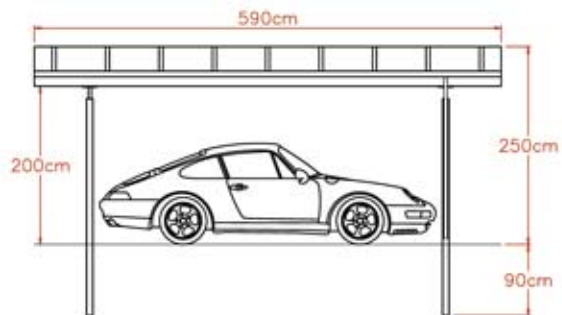
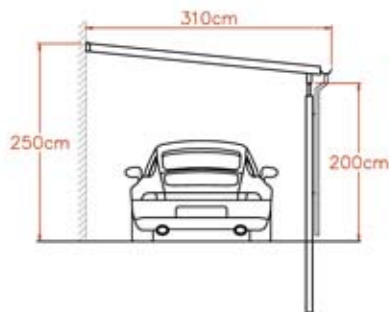
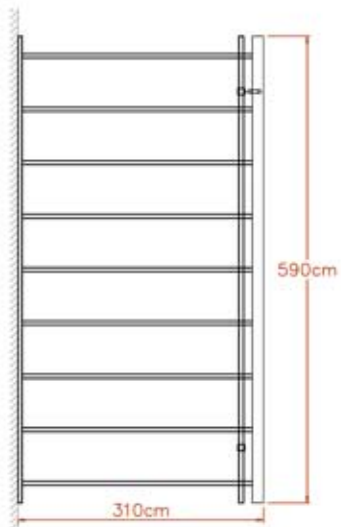

F01

DOUBLE ANBAU-CARPORT

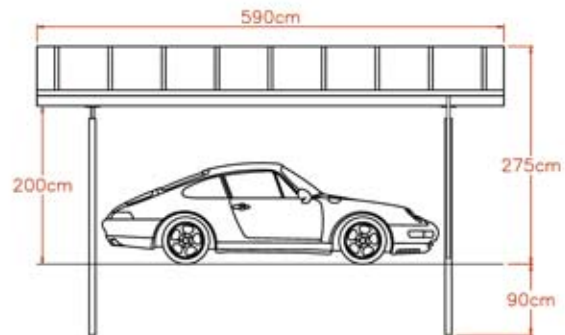
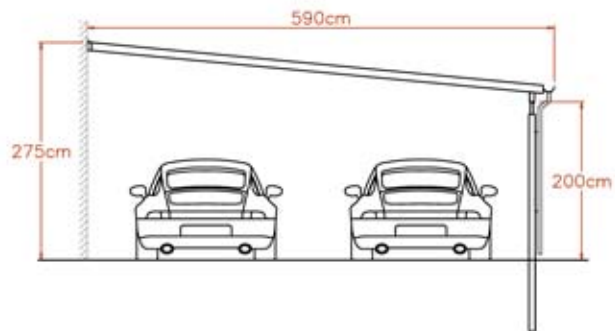
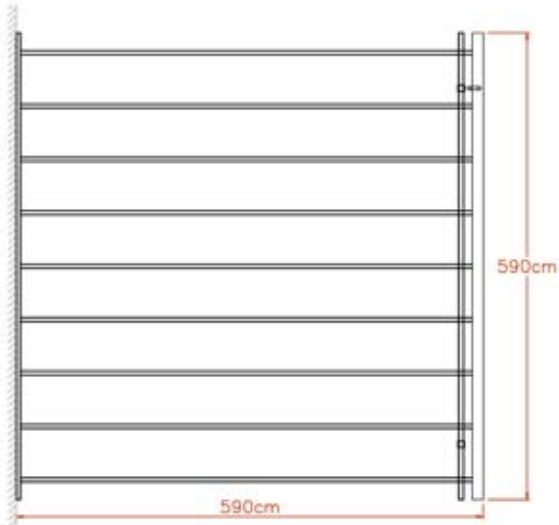

F02

SINGLE CARPORT

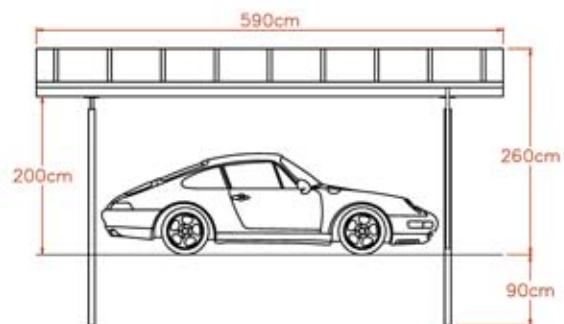
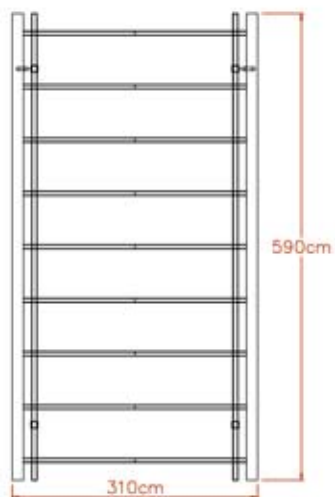

Q01

DOUBLE CARPORT

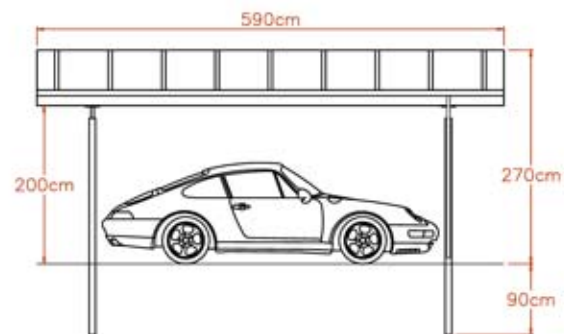
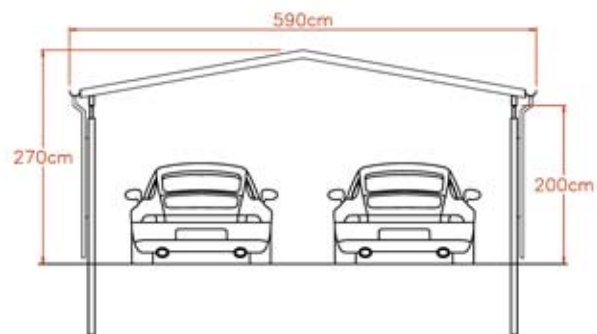
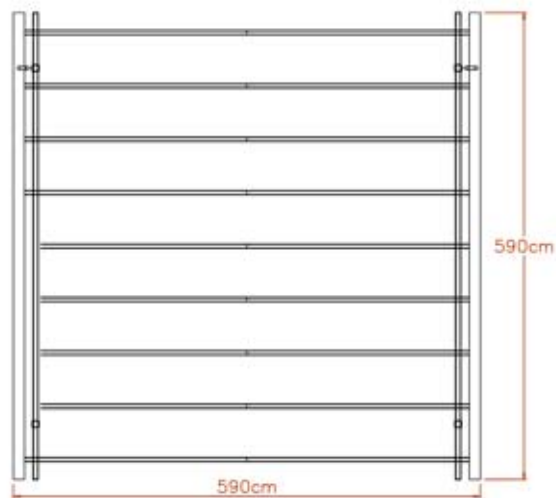

Q02

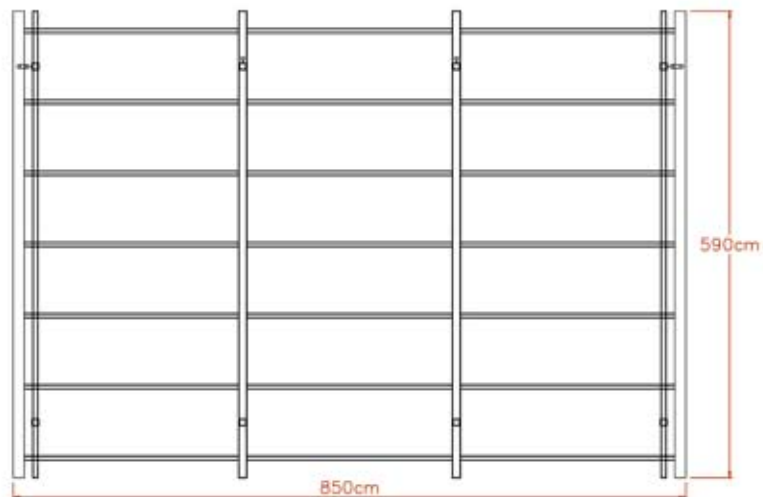

MULTIPLE CARPORT

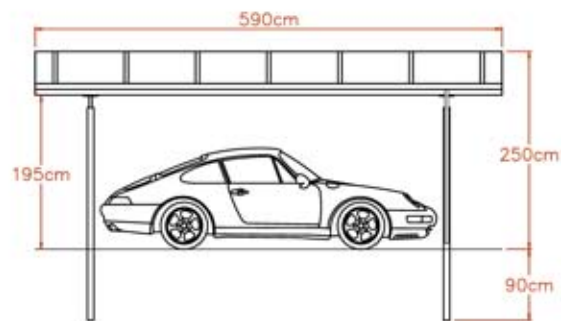
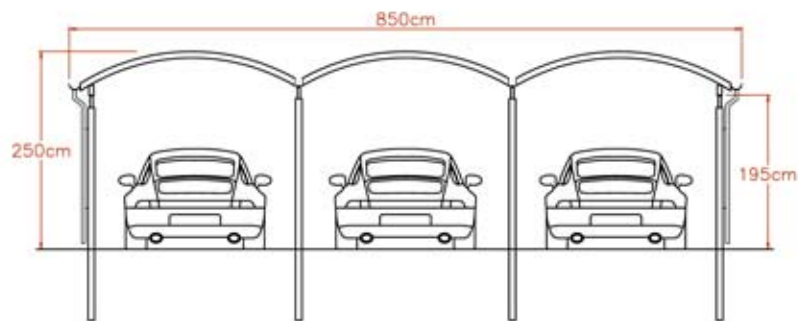

RM01

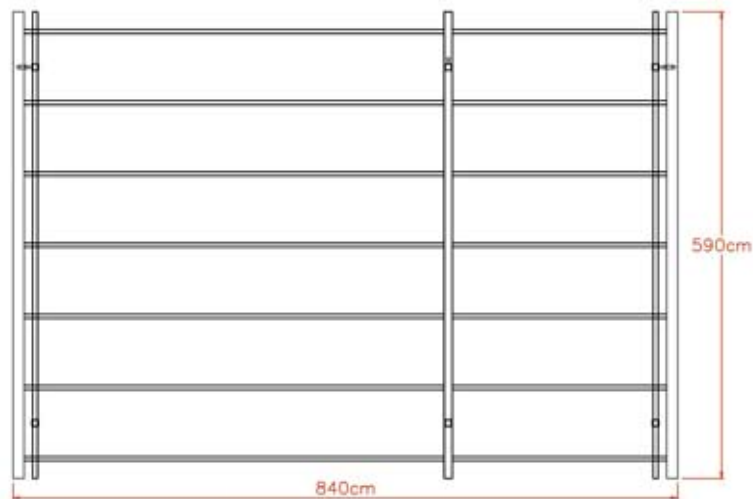

MULTIPLE CARPORT

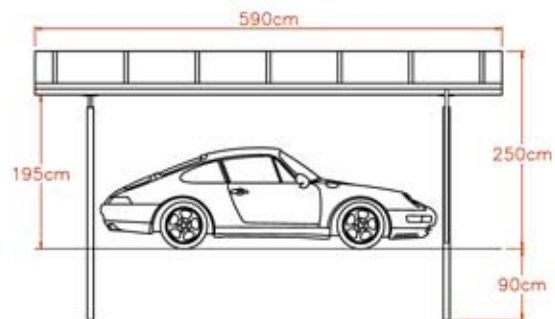
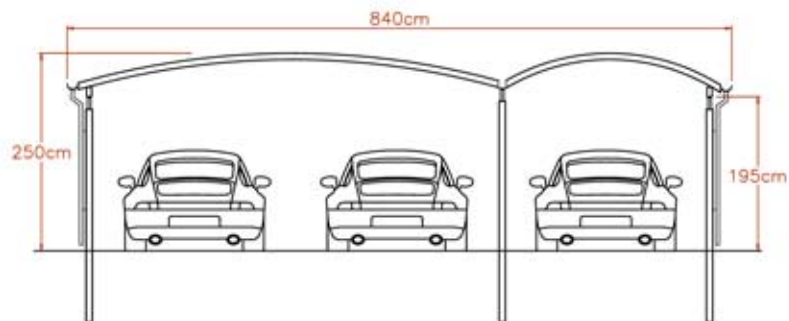

RMO2

MULTIPLE CARPORT

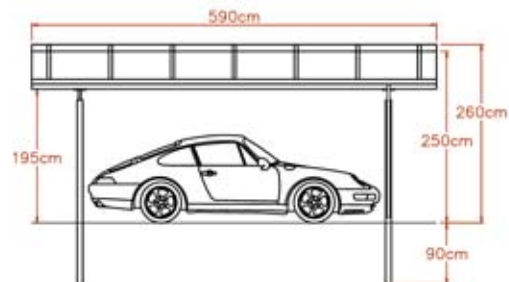
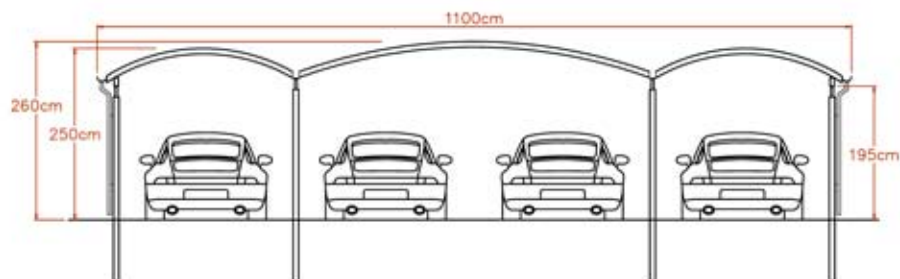
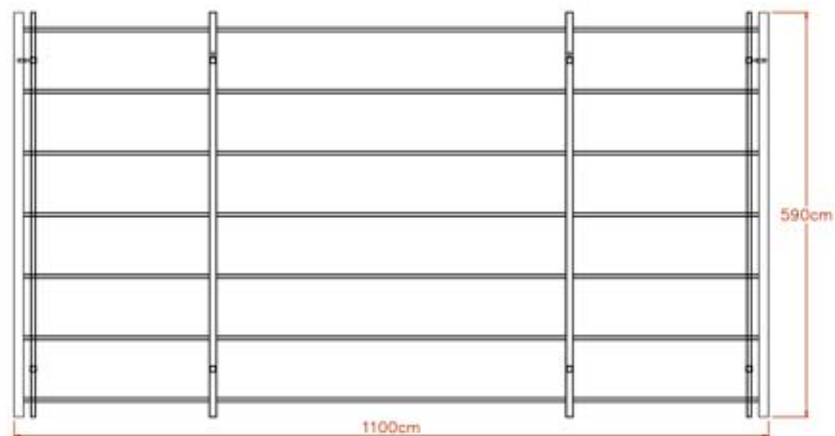

RM03

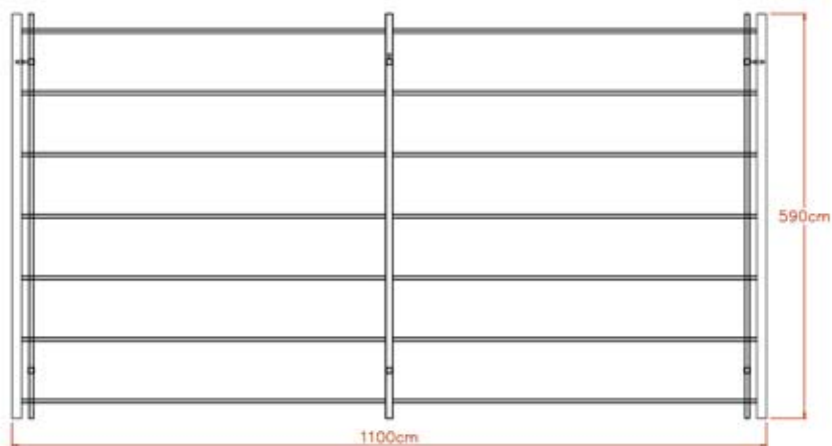

MULTIPLE CARPORT

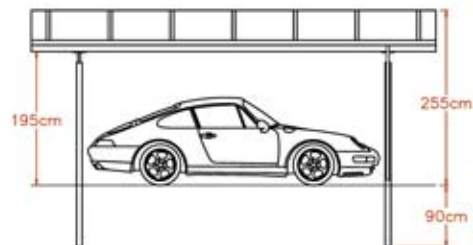
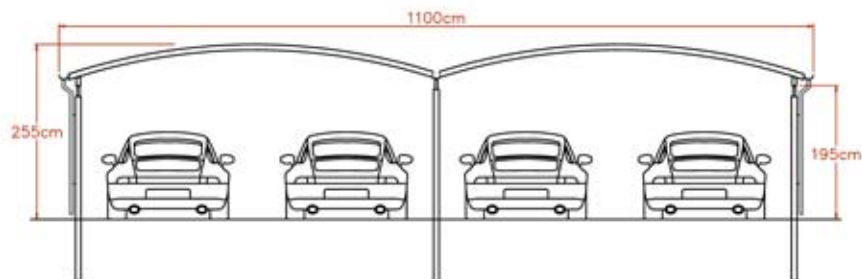

RM04

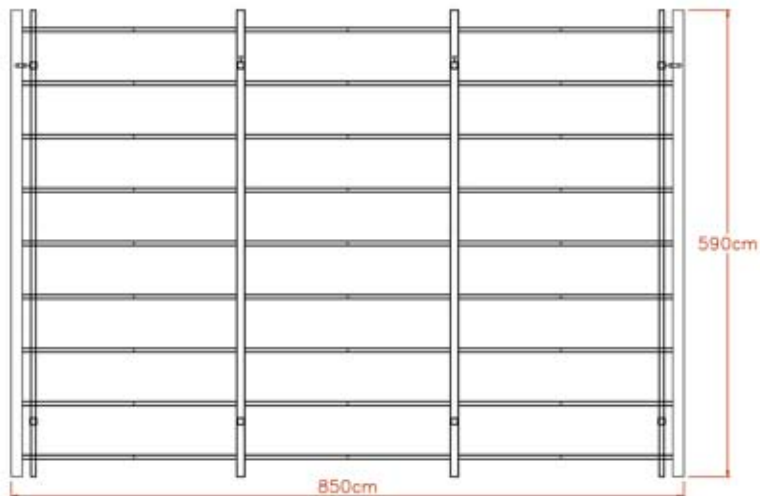

MULTIPLE CARPORT

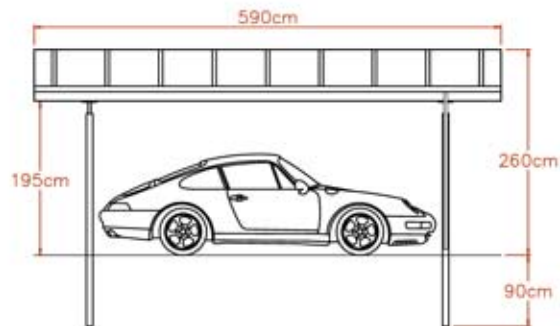
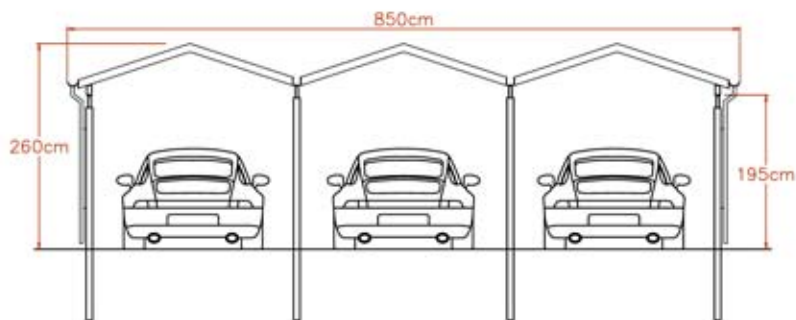

QM01

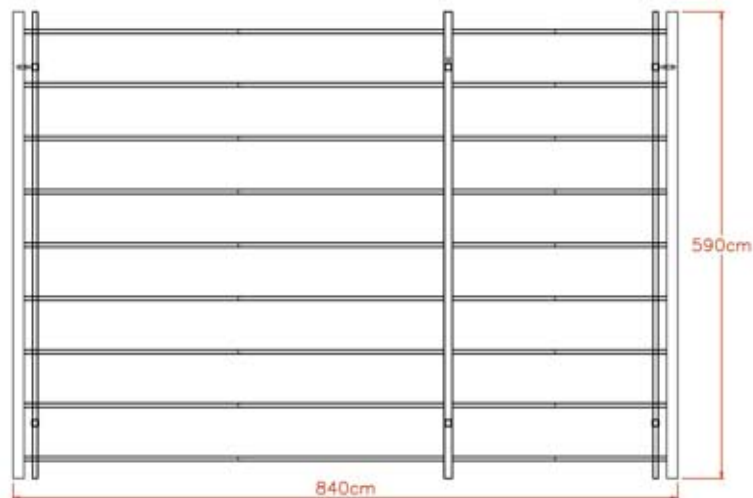

MULTIPLE CARPORT

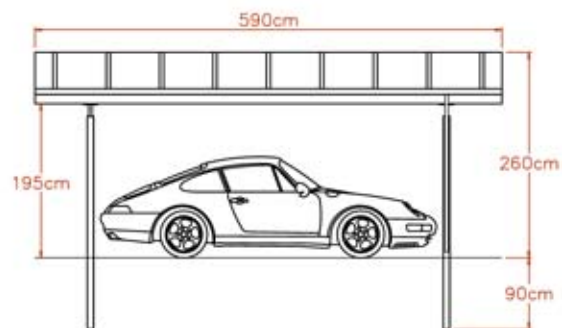
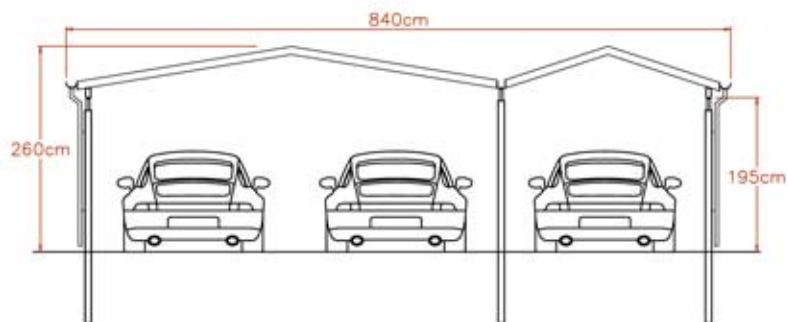

QMO2

MULTIPLE CARPORT

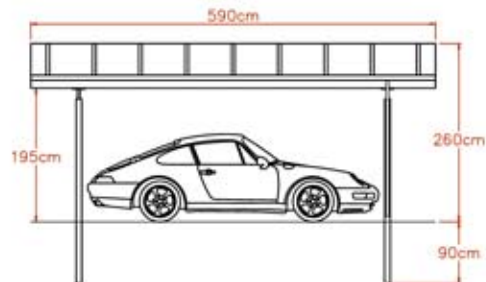
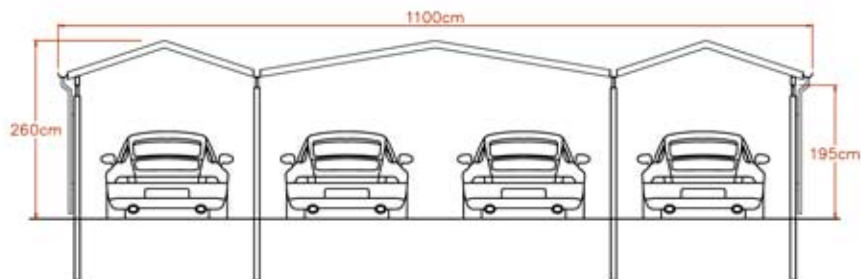
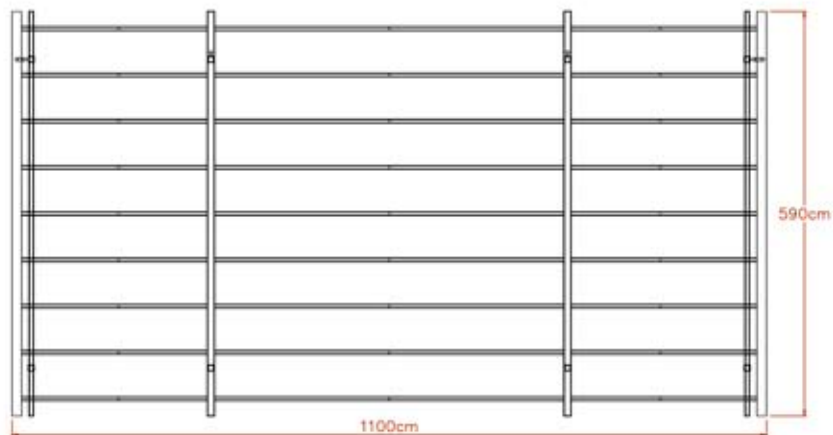

QM03

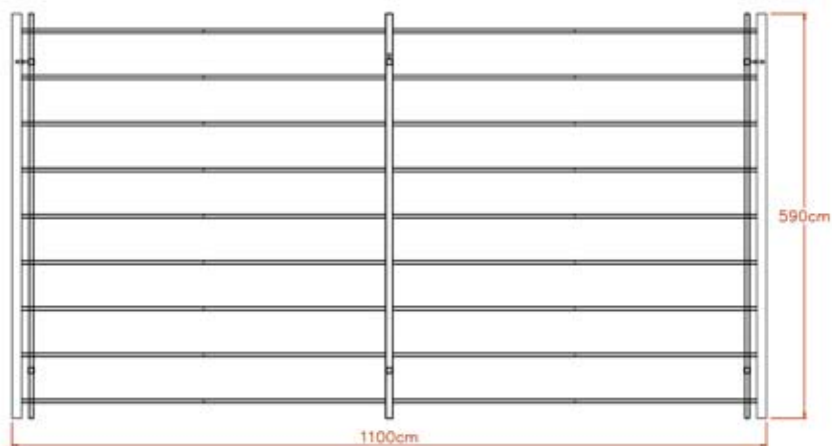

MULTIPLE CARPORT

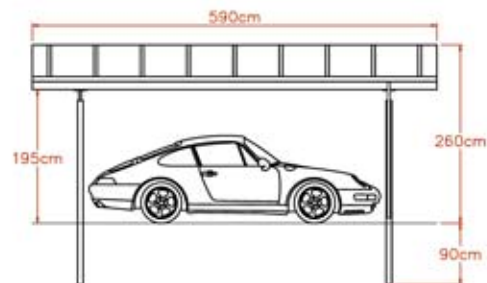
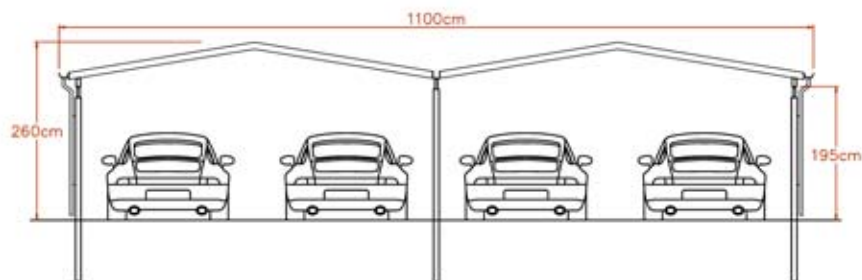

QM04